

Semiconductor wafer exhaust moisture displacement unit

Danny Chan¹, Jonghae Kim^{*}

¹Department of Electronic Engineering, Sun Moon University

반도체 웨이퍼 공정 배기가스 수분제어장치

진데니¹, 김종해^{*}

¹선문대학교 전자공학과

Abstract This paper introduces a safer and more power efficient heater by using induction heating, to apply to the semiconductor wafer fabrication exhaust gas cleaning system. The exhaust gas cleaning system is currently made with filament heater that generates an endothermic reaction of N₂ gas for the removal of moisture. Induction theory, through the bases of theoretical optimization and electronic implementation, is applied in the design of the induction heater specifically for the semiconductor wafer exhaust system. The new induction heating design provides a solution to the issues with the current energy inefficient, unreliable, and unsafe design. A robust and calibrated design of the induction heater is used to optimize the energy consumption. Optimization is based on the calibrated ZVS induction circuit design specified by the resonant frequency of the exhaust pipe. The fail-safe energy limiter embedded in the system uses a voltage regulator through the feedback of the MOSFET control, which allows the system performance to operate within the specification of the N₂ Heater unit. A specification and performance comparison from current conventional filament heater is made with the calibrated induction heater design for numerical analysis and the proof of a better design.

요약 본 논문은 반도체 웨이퍼 공정 배기가스 수분제어장치에 적용하기 위하여 인덕션 히터를 사용해서 안전하고 효율적인 전력을 사용하는 히터에 대한 설계방법을 제안한다. 수분을 제거하기 위해서 질소 가스의 흡열 반응을 발생하는 필라멘트 히터를 이용하여 배기가스 제거 시스템이 만들어진다. 이론적인 최적화와 전기적인 구현을 통해서 인덕션 이론은 반도체 웨이퍼 공정 배기가스 시스템을 위한 인덕션 히터 설계과정에 적용되어진다. 제안한 인덕션 히터 설계는 에너지 측면에서 비효율적이고 신뢰성이 떨어지며 안전하지 못한 현재의 설계문제에 대한 해결책을 제시한다. 인덕션 히터의 강인성과 미세조정 설계기법이 질소 히터의 사양내에서 에너지 소모를 최적화한다. 최적화는 배기 파이프의 공진주파수에 의해서 특성화된 ZVS(Zero Voltage Switching)를 기초로 이루어진다. 시스템에서 끼여진 고장 안전(fail-safe) 에너지 리미터는 MOSFET의 레환 제어를 통하여 전압 레귤레이터를 사용하고 N₂ 히터 유닛의 사양내에서 작동하기 위한 성능을 만족하도록 한다. 수치 해석과 설계의 우수성을 위한 기존의 필라멘트 히터와 미세조정된 인덕션 히터 설계의 사양과 성능비교는 제안한 인덕션 히터 설계방법이 우수함을 보여준다.

Keywords : Exhaust Gas, Moisture Displacement Endothermic Reaction, Induction Heating, Hysteresis Effect, Remanence, Coercive Force, Resonant Frequency

1. Introduction

Semiconductor wafer exhaust moisture displacement

unit that processes unwanted by-product gas from the semiconductor wafer fabrication machine. The entire exhaust gas processing system is a cleaning system

*Corresponding Author : Jonghae Kim(Sun Moon University)

Tel: +82-41-530-2352 email: kjhae@sunmoon.ac.kr

Received January 30, 2015

Revised (1st May 18, 2015, 2nd July 17, 2015, 3rd July 22, 2015, 4th July 28, 2015)

Accepted August 6, 2015

Published August 31, 2015

which consists of several units, prior to releasing the gas into the atmosphere.

The role of the moisture displacement unit in the cleaning system is to remove moisture within the exhaust gas, which will prevent powders from congesting or clogging the pipes. The current exhaust gas cleaning system uses a device called the N₂ Heater unit to remove moisture. However, the N₂ Heater achieve its goal inefficiently, unreliable and unsafe. Hence, a new design using induction heating improves all aspects of the N₂ Heater's poor design. Power consumption, unit robustness, and safety are all key improvements with the new design.

2. Preliminary

A general illustration of the Semiconductor wafer exhaust gas cleaning system is shown on Fig. 1 below, which consist of several different units. Each unit has its own purpose of cleaning the exhaust gas. However, the Scrubber and Condenser units are not our topic of interest and will not be covered in this paper.

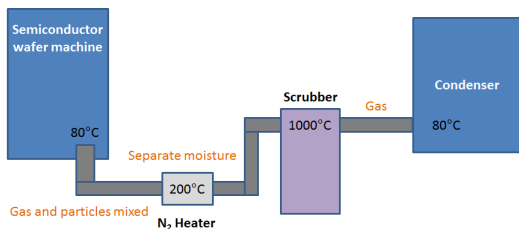

Fig. 1. Semiconductor wafer exhaust gas cleaning system.

The chemicals within the exhaust gas may vary depending on the type of process the semiconductor wafer machine performs. In table 1 below shows the type of process and the different chemicals produced by the wafer machine. Some of these gases listed below are extremely harmful to the environment, and deadly to human. In order to remove or neutralize these harmful gases, various stages are required in the

cleaning process.

Table 1. Types of semiconductor wafer fabrication process and by-product chemicals

| Process | Typical Gases | |
|-------------------|---|---|
| Dry Etch | Metal | Cl ₂ , BCl ₃ , SiCl ₄ , CHF ₃ , CF ₄ , SF ₆ |
| | Poly silicon | HBr, Cl ₂ , NF ₃ , SF ₆ |
| | Nitride | HBr, CF ₄ , SF ₆ |
| | W, Al Oxide | Cl ₂ , SF ₆ , CHF ₃ , CF ₄ , NF ₃ |
| PECVD | BPSG | TEOS, TMP, TMB, N ₂ O, SiH ₄ , B ₂ H ₆ , PH ₃ , C ₂ F ₆ /NF ₃ |
| | PSG | SiH ₄ , PH ₃ , N ₂ O, TEOS, TMP, C ₂ F ₆ /NF ₃ |
| | Oxide/Nitride | SiH ₄ , NH₃ , N ₂ O, C ₂ F ₆ /NF ₃ |
| | Tungston | WF ₆ , NF ₃ , SiH ₄ |
| LPCVD | Nitride | DCS, NH₃ |
| | Poly silicon | SiH ₄ |
| | (doped) TEOS | TEOS, PH ₃ |
| Ion Implant (Dry) | B ₂ H ₆ , BF ₃ , PH ₃ , AsH ₃ , Ar | |
| MOCVD | GaAs | H ₂ , AsH ₃ , MOSources |
| | InP | H ₂ , PH ₃ , AsH ₃ , MOSources |
| | GaN | H ₂ , NH₃ , MOSources |

2.1 N₂ Heater

The first step of the cleaning process is to remove moisture from the exhaust gas. The N₂ Heater unit in Fig. 2 on the right, which is this paper is main focus, removes water vapors within the mixed gas and particles by separating the water molecules into different form of substances.



Fig. 2. N₂ Heater unit

The moisture in the exhaust gas will act as a bond with the particles and the pipe, causing flow congestion or clog. This will lower production or even a production halt. Fig. 3 below illustrates the use of the

N₂ Heater unit.

Fig. 3. N₂ Heater unit reduces flow congestion
(a) Without N₂ Heater unit (b) With N₂ Heater unit

The N₂ Heater removes moisture by injecting N₂ into the pipe and heat the exhaust gas to over 200°C. This allow the moisture to combine with N₂ and form Ammonia (NH₃) and oxygen (O₂) gas. As shown in Table 1, underlined in bold, NH₃ is a common by-produce for all non-dry processes.

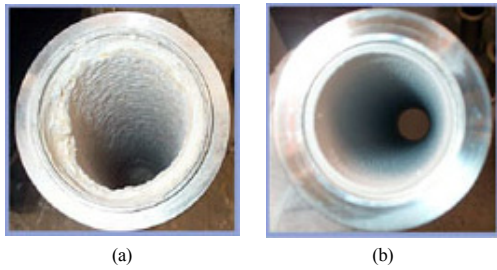
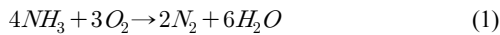

The forward reaction of Eq. 1 is an exothermic reaction, where $\Delta H = -1530 \text{ KJ}$. [11] However, the reverse reaction to Eq.1 is needed for the removal of water vapor. Therefore, an endothermic reaction is inducted by the N₂ Heater unit. The energy required for this endothermic reaction is +1530 KJ, or 425 Wh [6], to remove 6 mol of water. To produce such energy, the N₂ Heater uses a simple heat filament coil heater that wraps around the pipe. N₂ gas is injected from the side of the pipe and then heated to 200°C to create the endothermic reaction of NH₃.

2.1.1 N₂ Heater inefficiency and safety issue

Inside the N₂ Heater, the heat filament is not directly exposed to the environment, it is covered by a heat reflector that is primary steel, and a hexagonal steel cover that is wrapped around the entire unit with an 5 cm air gap in between the reflective layer.

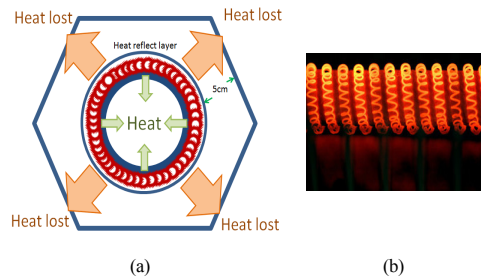

Fig. 4. N₂ Heater unit
(a) Cross-section view of the unit (b) Side inner view of the unit without the heat reflector.

In Fig. 4 (a) The thick inner blue circle is the SUS graded steel pipe, wrapped around in red is the heating filament coil, where Fig. 4 (b) shows a clear side view of this heating filament. The heater reflector, the outer blue circle in Fig. 4 (a), losses its ability to retain heat to long term exposure in high intense heat. Thus, the heater unit becomes inefficient and dangerous when the unit is saturated with heat.

Table 2. N₂ Heater Specification

| Item | Specification |
|--------------------|---|
| Tube | SUS316 |
| Unit: size, weight | 130(w) x 135(L), 2.5Kg |
| Heater | Cover: SUS, Pipe: SUS, Heat filament: Ni-Cr |
| Input Power | AC 220V 1P 15A |
| Power rating | 500W, 800W |
| temperature | 150°C, 200°C |
| Utility N2 | 3.6-7 kgf/cm2 |
| Leak Rate | 2.1x10 ⁻⁹ Torr l/sec |
| Flow rate | 30-70 LPM |
| Thermo sensor | K-type |
| Controller | PID controller |

The N₂ Heater unit is rated to produce up to 200°C, when the unit becomes saturated, the outer hexagonal steel cover is measured to have temperature over 110°C. Since only the inner surface of the heat filament directly touches the pipe, more than 50% of the power dissipation is lost to the external unit. Hence the new design will target this inefficient and unsafe aspects, which will significantly increase efficiency of power consumption and a safer design where heat is

not dissipated out on external cover.

2.2 Induction Heater objective

The primary objective of the Induction Heater is to eliminate the use of filament heating coils and implement a permanent solution for removing moisture from the exhaust gas. Thus, specific specifications were targeted to overcome the existing problems and inefficient design as listed in table 3.

The new design is able to raise the pipe internal temperature to approximately 200°C in order to create the endothermic reaction for the N₂ gas to react with the water vapor.

Table 3. Solution specifications

| Specifications | Current values | Target values |
|-------------------------|--|--------------------------------|
| Heater coil replacement | Ni-Cr filament, replace every 3 months | Induction coil, no replacement |
| Temperature | 200°C | 200°C |
| Outer case temperature | +100°C | room temperature |
| Power rating | 800 watts | 200 watts |

The secondary objective of the induction heater is to eliminate safety hazard, where users will not be injured while operating around the heater. Thirdly, induction heating can improve production since there is less down time for maintenance, and does not require any replacement within the heating unit. Oppose to the current design, the heating coil is a wear and tear item which requires regular maintenance and annually replacement.

3. Methodology

3.1 Induction heating overview

Induction heating is a non-contact heating process. It uses high frequency electricity to heat materials that are electrically conductive. High frequency electricity is used to drive large alternating current through a coil. This coil is known as the work coil highlighted in

orange, shown on Fig. 5 below.

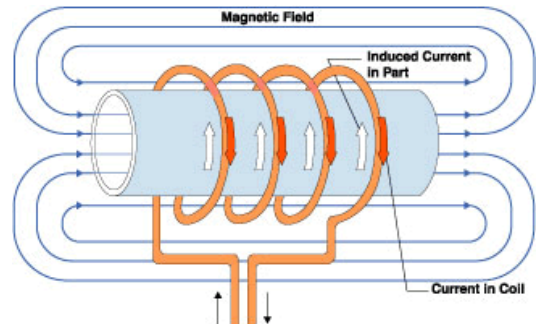

Fig. 5. Magnetic Induction

As current passes through the work coil, a magnetic field is created and magnetic hysteresis takes effect [4]. The workpiece is placed within this coil where intense alternating magnetic field passes through it. Heat is generated by hysteresis effect on materials that have significant relative permeability, which are ferromagnetic materials. Iron is most effective material for induction heating. When an external magnetic field is applied to a ferromagnetic material, the atomic dipoles align themselves with it. Even when the field is removed, part of the alignment will be retained: the material has become magnetized. Once magnetized, the magnet will stay magnetized indefinitely. demagnetization requires a magnetic field in the opposite direction. Hence, the high speed flipping in the magnetic field will generate extremely high amount of heat [4].

3.1.1 How hysteresis effect generates heat

The field strength H and magnetization M is not linear in ferromagnetic materials, such as steel pipes, shown in Fig. 6.

As the current turns on and off in the coil, shown in Fig 7, the field strength creates a remanence [3]. The remanence is the resistance force of ferromagnetic material of becoming demagnetized. Thus, a force, known as the coercive force, is required to overcome the remanence to flip the dipole in the opposite direction where the magnetization goes from positive

saturation to negative saturation. It is this resistance force which causes heat when the dipoles are forcefully flipped.

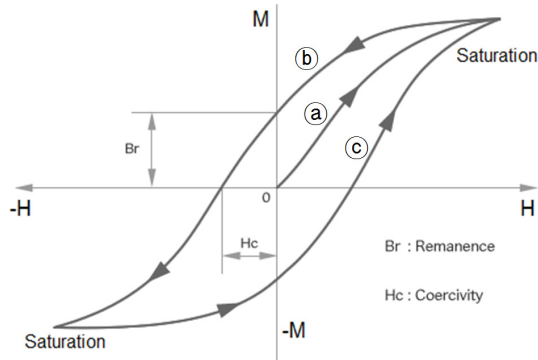

Fig. 6. Hysteresis Effect - Hysteresis loop

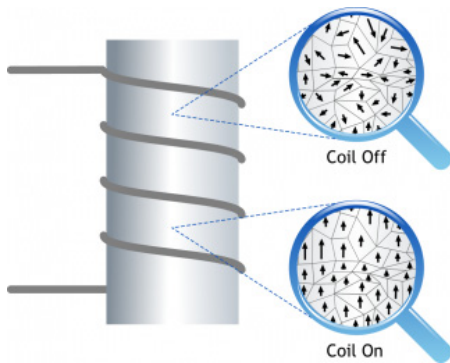

Fig. 7. Hysteresis Effect - Remanence in pipe

3.2 The design

The design of the new heater does not require to heat large amount of steel, but a very dense steel, SUS graded stainless steel. SUS has a higher density than regular steel, thus, the resonant frequency is lower. Industrial inductance heater smelt steel at nominal frequencies of 1kHz or 500Hz. These nominal frequencies uses extreme high currents, ranging from 600A - 2500A at 380V, smelting the steel at temperature of 1600°C. [10] However, at 1kHz nominal frequency or lower, the power consumption is too high for the required specification listed on table 3. By altering the frequency higher the power consumption reduces and also the rate of heating. To

find the optimal frequency, the induction of the working coil must be known, in order to find the resonant frequency produced by the inductor. Eq. 2 below is the formula of the coil inductance. [9]

$$L = \frac{Radius^2 \times Turns^2}{9Radius + 10Length} \quad (2)$$

where the coil radius is 4.5cm, 6 number of turns, and a length of 200cm. Refer to Fig. 8 below.



Fig. 8. Work coil prototype

This yields a coil inductance of 0.141mH. The inductor resonant frequency can then be predicted by Eq. 3 below [9],

$$F = \frac{1}{2\pi \sqrt{L \times C}} \quad (3)$$

where L is the coil inductance and C is the tank capacitor capacitance. The tank capacitor capacitance is chosen to be 43.7uF, which according to the formula above yields a resonant frequency of 64.116kHz. The measured frequency produced by the inductor to be 63.23kHz, using 5.08A and input voltage of 21.5V.

This 63.23kHz resonant frequency is chosen to be the optimal frequency based on the constraint of the saturated MOSFET. Hence, voltage supply may not exceed 25V limit, and current drawn may not exceed

9A at 21.5V or 200W.

Table 4 below illustrates the condition when different capacitance are used as Tank Capacitor. With 43.7uF as the inductor’s capacitance, the resonant frequency is 63.23kHz. By incrementing and decrementing the capacitance of 6.8uF, or resulting frequencies will yield a different temperature result. The decrement capacitance 36.9uF will yield a frequency of 71.42kHz, and the increment capacitance 50.5uF will yield a 58.6kHz. For frequencies 71.42kHz and higher, the maximum temperature is too low, which does not meet the specification. On the other hand, frequencies lower than 58.6kHz draws too much current, and the MOSFET over heats and burns out. Hence, to maintain robustness in the circuitry, leaving a significant safety margin for the MOSFET to operate at a normal condition is considered. The optimal frequency which best fit the specification would be 63.23kHz.

Table 4. Optimal Frequency Test

| Resonant Frequency (kHz) | Current & Voltage | MOSFET Temp. (°C) | Pipe Max Temp. (°C) |
|--------------------------|-------------------|-------------------|---------------------|
| ↑ | ↑ | COOL | BELOW SPEC. |
| 71.42 | 24V@5.23A | 43.0 | 141 |
| 63.23 | 24V@6.60A | 74.2 | 188 |
| 58.6 | 24V@7.89A | 91.5 | 223 |
| ↓ | ↓ | BURNT OUT | N/A |

3.2.1 Robust ZVS induction circuitry design

A simply ZVS induction circuit is used for testing purposes. ZVS, Zero Voltage Switching, is the most efficient configuration for MOSFET at high speed switching. Other configuration such as Full H-bridge or Half-bridge are too inefficient, where the MOSFET generates too much heat itself. Although the ZVS is an analog design, meaning the temperature is manually controlled by the voltage input; however, if the desired temperature is within the range of this circuitry design, then it is the most efficient design.

Aside from being efficient, the circuit also acquires

a 12V regulated voltage for both MOSFET’s gates, the regulator limits the MOSFET’s gates from being over saturated. Therefore, the gate will always be fully open for high currents to pass through, and not to generate excessive heat, allowing the MOSFET to operate at a safe specified condition. However, beyond 25V input voltage, the regulator will start to breakdown and the MOSFET will no longer be operational.

Although other MOSFET models may allow higher current and higher input voltage, the current design uses minimal current to achieve a temperature that satisfy the specification. Unless a higher temperature is required, the current design is sufficient, efficient, and robust.

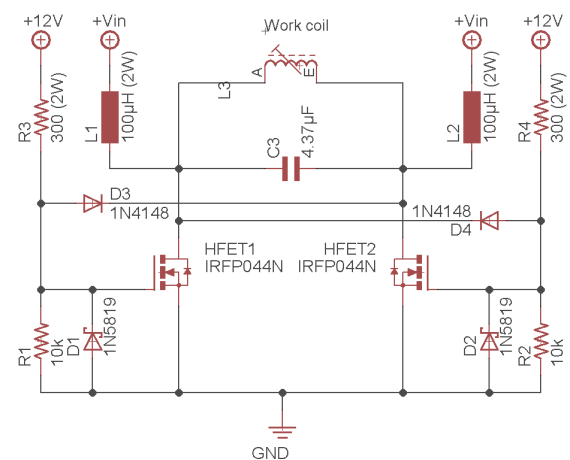

Fig. 9. Robust ZVS induction circuit.

In Fig. 9, L3 is the work coil, and C3 is the Tank capacitor. +Vin is the input voltage which can be controlled to input 12V to 25V. +12V is actually regulated by a 12V regulator which has the same input voltage as +Vin. This allows the circuit to be controlled by a single input source reducing excessive energy lost.

4. Results

4.1 Temperature results

The table 5-7 on the right are the results of different

input voltages. Since the temperature is directly controlled by the voltage input, power consumption can be traced and also the rate for which the max temperature is reached. At the resonant frequency of 63kHz, the time for the pipe to heat up to 188°C takes about 30 minutes. Since time is not one of our constraint, by allowing the temperature to charge up can reduce to power consumption. The voltage interval for this test are arbitrary chosen to test the range of the induction heater before maximizing the input voltage and stress out the circuit.

Table 5. Pipe Temperature rate at 15V

| Time (min) | Current (A) | Pipe temp. (°C) | Coil temp (°C) |
|----------------------|-------------|-------------------|-------------------------|
| 0 | 3.51 | 24.25 | 25.97 |
| 5 | 3.58 | 59.11 | 39.22 |
| 10 | 3.63 | 69.48 | 40.68 |
| 15 | 3.65 | 71.17 | 38.97 |
| 20 | 3.68 | 78.39 | 42.14 |
| 25 | 3.68 | 81.04 | 41.17 |
| 30 | 3.68 | 80.80 | 41.17 |
| Input Voltage: 15.0V | | Output RMS: 29.1V | Output Amplitude: 81.0V |

Table 6. Pipe Temperature rate at 20V

| Time (min) | Current (A) | Pipe temp. (°C) | Coil temp (°C) |
|----------------------|-------------|-------------------|--------------------------|
| 0 | 4.68 | 21.03 | 25.97 |
| 5 | 4.82 | 85.61 | 42.63 |
| 10 | 4.88 | 115.37 | 56.21 |
| 15 | 4.90 | 131.02 | 59.36 |
| 20 | 4.94 | 143.59 | 61.53 |
| 25 | 4.94 | 148.55 | 64.42 |
| 30 | 4.98 | 149.79 | 64.42 |
| Input Voltage: 20.0V | | Output RMS: 39.0V | Output Amplitude: 109.0V |

Table 7. Pipe Temperature rate at 24V

| Time (min) | Current (A) | Pipe temp. (°C) | Coil temp (°C) |
|----------------------|-------------|-------------------|--------------------------|
| 0 | 6.64 | 24.00 | 24.00 |
| 5 | 6.52 | 121.22 | 64.42 |
| 10 | 6.60 | 155.75 | 71.17 |
| 15 | 6.62 | 169.23 | 77.19 |
| 20 | 6.62 | 182.75 | 75.26 |
| 25 | 6.58 | 187.01 | 75.98 |
| 30 | 6.60 | 188.01 | 75.26 |
| Input Voltage: 24.0V | | Output RMS: 46.1V | Output Amplitude: 127.0V |

Fig. 10 and 11 below illustrates the rising of the temperature in the pipe and the work coil. The input voltage of 24V yields the best temperature output, that is within the specification. In table 7, the pipe highest temperature is recorded to be 75.98°C, any higher input voltage will cause the work coil to be extremely warm and unsafe.

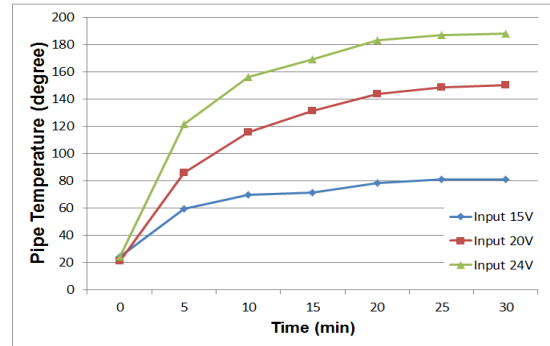

Fig. 10. Pipe temperature

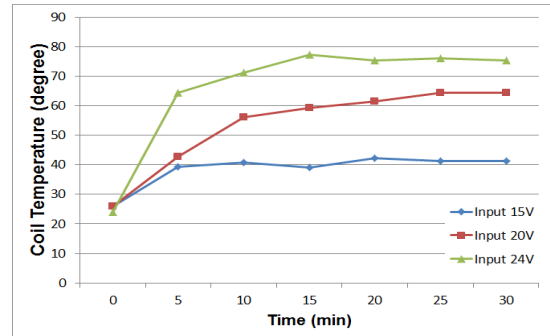

Fig. 11. Coil temperature

4.2 Power results

As expected in the design of the induction heater, it is approximately 5 times more energy efficient than the current N₂ Heater according to table 8 below.

Table 8. Power rating comparison

| Heater setting | Power (watts) | Pipe temp. (°C) | Outer temp. (°C) |
|-----------------------------|---------------|-----------------|------------------|
| I.H. (15V) | 55.2 | 80.8 | 41.17 |
| I.H. (20V) | 99.6 | 149.79 | 64.42 |
| I.H. (24V) | 158.4 | 188.01 | 75.26 |
| N ₂ Heater(600W) | 500 | 150 | 110 |
| N ₂ Heater(800W) | 800 | 200 | 130 |

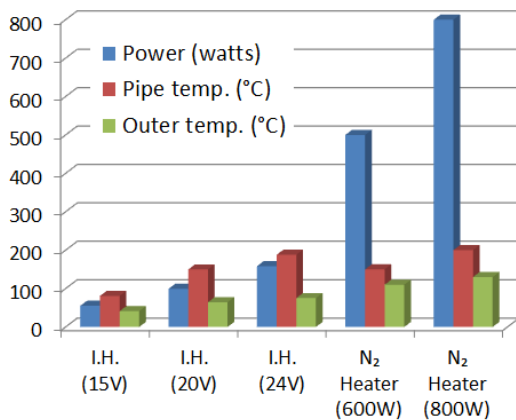

Fig. 12. Power rating graph

Fig. 12 is a graphical representation of table 7. However, it is very clear that for both N₂ Heater setup, the amount of power consumed is far more than the temperature outputs. Therefore, induction heating clearly saves energy.

4.3 Safety results

The N₂ Heater unit external temperature is measured to be at approximately 130°C at 800W setting. However, the most outer layer of the induction heater unit is the coil, and as a prototype, heat reflector or insulator is not installed for testing purposes. Yet the temperature is recorded to have a maximum of 75°C, which is considered to be very warm, but not dangerous when exposed to such temperature. The induction heater outer temperature can be further lowered if there is heat reflector or insulator to eliminate any heat hazards.

5. Conclusion

The prototype induction heater unit has proven to be far more energy efficient and safer than the N₂ Heater. Since the energy consumption is significantly brought down, this allows more room for improvement in the removal of moisture in the exhaust gas. By increasing

the wattage of the induction heater, it increases the heat to allow more water molecules be separated and form ammonia. Furthermore, by proper shielding of the induction heater unit, the external temperature could be made overall insignificant. Such as coating the pipe with ceramic to insulator the heat from escaping, or add a external cover similar to the N₂ Heater.

All in all, regardless of the above improves, the test has shown the objective of the induction heater unit is met and can be exceed the current N₂ Heater unit. Since the induction heater can offer much more, with the right amount heat, part or maybe all of the scrubber unit maybe be replaced by this induction heater unit.

References

- [1] J. Michael Sherer, *Semiconductor Industry: Wafer Fab Exhaust Management*, p.13-27, CRC Press, 2010.
- [2] Brighter Company. Hot N₂ System [Internet]. Brighten.co.kr. c2008. Available From: http://www.brighten.or.kr/gnuboard4/bbs/board.php?bo_table=brighten2_p5. (accessed Nov., 21, 2014)
- [3] Livingston, J. D. "A review of coercivity mechanisms". *Journal of Applied Physics*, 52 (3): 2541 - 2545, 1981. DOI: <http://dx.doi.org/10.1063/1.328996>
- [4] Gaunt, P. "Magnetic viscosity and thermal activation energy". *Journal of Applied Physics*, 59 (12): 4129 - 4132. 1986. DOI: <http://dx.doi.org/10.1063/1.336671>
- [5] SemiAn Technology. Burn plus wet scrubber for exhaust gas cleaning. [Internet] Crystec.com, Crystec Technology Trading GmbH. c2004. Available From: <https://www.crystec.com/ksiburne.htm> (accessed Nov., 21, 2014)
- [6] Rajaput, R. K., *A Textbook of Electrical Engineering. Introduction to SI Units and Conversion Factors*, p.xix-xxi, LAXMI Publications. 2003.
- [7] Jiles, D. C., Atherton, D. L. "Theory of ferromagnetic hysteresis". *Journal of Magnetism and Magnetic Materials* 61: 48 - 60, 1986. DOI: [http://dx.doi.org/10.1016/0304-8853\(86\)90066-1](http://dx.doi.org/10.1016/0304-8853(86)90066-1)
- [8] Rudnev, Valery. *Handbook of Induction Heating*, p.92-93, CRC Press, 2003.
- [9] American Radio Relay League. *The ARRL Handbook for*

Radio Communications 2010. p.5.3-5.9, American Radio Relay League, 2009.

- [10] Zhu Zhu Shuangling Technology. IF Inductive Smelting Furnace [Internet]. Zhu Zhou Shuangling Technology Co., LTD. c2002. Available From: http://www.hnsl.net/en/products_e_show.asp?id=106 (accessed Dec. 4, 2014)
- [11] Haase, R. *In Physical Chemistry: An Advanced Treatise*, Jost, W., Ed., p 29, Academic: New York, 1971.
DOI: <http://dx.doi.org/10.1021/j100693a006>

Danny Chan

[Associate member]

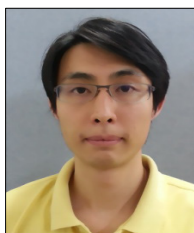

- July 2007 : York Univ.(Canada), Earth and Space Science and Engineering, Space Engineering
- Sep. 2007 ~ Aug. 2009 : Qauntec Geoscience Inc., Jr. Geophysicist.
- Mar. 2013 ~ Present : Sun Moon Univ., Dept. of Electronic Engineering, M. Eng.

<Research Interests>

Control Applications, Geophysics, Space Science

Jonghae Kim

[Regular member]



- Feb. 1995 : Dept. of Electronics, Kyungpook National Univ. (Master's Degree)
- Aug. 1998 : Dept. of Electronics, Kyungpook National Univ. (Ph. D.)
- Nov. 1998 ~ Feb. 2002 : Sensor Tech. Research Center (Full-time Researcher)
- Mar. 2000 ~ Mar. 2001 : Osaka Univ. (Research Fellow)
- Jan. 2010 ~ Feb. 2011 : Georgia Institute of Tech. (Visiting Research Scholar)
- Mar. 2002 ~ Current : Dept. of Electronic Eng., Sun Moon Univ. (Professor)

<Research Interests>

Robust Control, Robust Filtering, Signal Processing, Industrial Application Systems