

# Experimental validation of a dynamic analysis and fuzzy logic controller of greenhouse air temperature

Imen Haj Hamad<sup>†</sup>, Amine Chouchaine<sup>††</sup> and Hajer Bouzaouache<sup>†††</sup>

[imen.hadjhamad@enicar.u-carthage.tn](mailto:imen.hadjhamad@enicar.u-carthage.tn)

<sup>†</sup> LARA, National Engineering School of Carthage, University of Carthage, Tunisia.

<sup>††</sup> UR-LAPER, Faculty of Sciences of Tunis, University of Tunis EL Manar, 2092, Tunisia.

<sup>†††</sup> LARA, National Engineering School of Tunis, University of Tunis El Manar, Tunisia.

## Abstract

The greenhouse is a complex system. It is subject to multiple input disturbances that are highly dependent on meteorological conditions, which are generally nonlinear and have a great influence on the agricultural production. The objective of this paper is to study the fuzzy logic technique as one of the most efficient technologies to control the greenhouse. The fuzzy logic controller (FLC) was developed to activate the actuator based on a ventilator was installed in an experimental greenhouse to obtain a desired temperature of the microclimate despite the external disturbances.

**Key words:** Greenhouse, fuzzy logic controller, temperature, MATLAB/Simulink environment, Experimental validation.

## 1. Introduction

Greenhouse cultivation is an important economic sector in many countries around the world. In order to extend the production period of plants and improve performance, a production management system is needed [1].

Nowadays, the greenhouse is the main solution to the effects of meteorological change, its first goal is to effectively control the environment and protect plants against diseases by creating a favorable environment. Therefore, the agricultural greenhouse is a largely proven solution for unfavorable meteorological conditions and to protect the canopy against diseases. The process is a complex system [2,3], which can be characterized by a nonlinear system with multiple input-output (MIMO) [4,5], that depends on external climatic conditions such as outdoor temperature, outdoor relative humidity, wind speed and solar radiation. The modeling of greenhouse is carried out rapidly and aims to predict the evolution of the internal microclimate. The model can be static [6], it is simple to control and energy consumption is determined from global heat losses but its accuracy is extremely limited. On the other hand, dynamic models are more complex and are not easy to simulate over long periods of time. They require a large amount of computing time and very significant resources. However, these models show good accuracy. It is for this reason that the majority of

these studies have chosen to use the dynamic model, given its accuracy, to model the greenhouse. Generally, there are three main categories of modeling which are the knowledge model, this method is based on the approach of numerical resolution of the differential equations to describe the dynamic model of the different climatic parameters, very many authors have used these categories [7], the simplified model which is developed using knowledge model simplifications and the Behavioral Model [8,9], which is based on the identification technique based on an experimental analysis in order to find a mathematical model illustrating the evolution of the climatic parameters. Thus, the control is an important factor for the climate inside the greenhouse to provide a favorable microclimate for the desired growing conditions.

To maintain a microclimate adapted to the requirements of the protected crop, it is necessary to install a control system which is an important factor for the indoor climate of the greenhouse to ensure a microclimate favorable to the desired growth. Various greenhouse control systems have already been mentioned. For example, a method of monitoring feedback has been discussed in [10,11]. The control system described in [12,13] has been developed to provide an optimal method of control. In [14,15], the Fuzzy Logic Control (FLC), Adaptive Neuro Fuzzy control (ANFIS), Artificial Neural Network control (ANN) and PI control, were developed. The PI controller (SSODPI and PI-SSOD event-based controllers [16]. In [17], the authors studied model predictive control (MPC). Air temperature control by the Takagi-Sugeno (TS) method [18]. Adaptive Predictive Control, PID controllers [19] and non-linear adaptive PID [20]. In [21], the fuzzy logic controller was developed, which is the most widespread and widely used controller for nonlinear and complex systems such as greenhouses.

The objective of this work is to study and develop a dynamic model of the greenhouse environment that describes the energy behaviour of the internal temperature, followed by its experimental validation. Thus, a Fuzzy Logic Controller (FLC) was developed and simulated in

the MATLAB/Simulink environment to control the internal temperature of the greenhouse microclimate. This paper combines both the performance of the high technology control strategy and the efficiency of the modelling.

This remainder of this paper is organized as follows. Section 2 deals with the physical model of the greenhouse air temperature. In Section 3, the Fuzzy Logic Controller (FLC) strategy applied to the greenhouse, using the MATLAB/Simulink environment for experimental validation of greenhouse indoor temperature control. A comparative study of the simulation and validation results of the dynamic model with and without the controller is presented in section 4. The conclusion of the study is presented in the last section of the article.

## 2. Physical model of the greenhouse air temperature

### 2.1 Greenhouse Modeling

The mathematical model that describes the status of the greenhouse environment is based on the principles of the energy balance sheet. The models are detailed in [22]. This system is described by the following first-order differential equation:

$$\rho_a C_a V \frac{dT_{in}}{dt} = Q^{short} - Q^{conv,cond} - Q^{infilt} - Q^{long} - Q^{vent} \quad (1)$$

Where,  $\rho_a$  is the density of interior air ( $\text{Kg.m}^{-3}$ ),  $C_a$  is the Specific heat of air ( $\text{J. Kg}^{-1}. \text{K}^{-1}$ ),  $V$  is the volume of the greenhouse ( $\text{m}^3$ ), and  $T_{in}$  is the inside temperature ( $^{\circ}\text{C}$ ).

$Q^{short}$  is the solar energy consumed by the greenhouse was obtained by :

$$Q^{short} = \alpha_c \tau_c SI \quad (2)$$

With,  $\alpha_c$  is the Cover absorptivity of solar energy,  $\tau_c$  is the Cover Transfer,  $S$  is the surface of the greenhouse ( $\text{m}^2$ ), and  $I$  is the radiation from the solar ( $\text{W.m}^{-2}$ ).

$Q^{conv,cond}$  is the transfer of energy by the phenomena of convection and conduction that is described by :

$$Q^{conv,cond} = US(T_{in} - T_{out}) \quad (3)$$

Where,  $T_{out}$  is the outside temperature ( $^{\circ}\text{C}$ ),  $U$  is the overall heat transfer factor through the walls of the greenhouse ( $\text{W.m}^{-2}. \text{K}^{-1}$ ), it is calculated by :

$$U = \left[ \frac{1}{h_o} + \frac{L_c}{K_c} + \frac{1}{h_i} \right]^{-1} \quad (4)$$

With,  $K_c$  is the cover k (Polyethylene) ( $\text{W. m}^{-1}. \text{K}^{-1}$ ),  $L_c$  is the cover thickness (m),  $h_o$  is the convective heat transfer coefficients of the outside cover and  $h_i$  is the convective heat transfer coefficients of the inside cover of the greenhouse ( $\text{W.m}^{-2}. \text{K}^{-1}$ ). They are obtained from following relations :

$$h_o = 2.8 + 1.2V_w \quad (5)$$

$$h_i = 1.52 |T_{in} - T_{out}|^{\frac{1}{3}} + 5.2 \left( \frac{R}{S_c L} \right)^{\frac{1}{2}}$$

(6)

With,  $V_w$  is the evolution of the outside wind speed ( $\text{m.s}^{-1}$ ),  $R$  is the number of air changes per hour ( $\text{m}^3.\text{s}^{-1}$ ),  $S_c$  is the Vertical section of the greenhouse ( $\text{m}^2$ ) and  $L$  is the length of the greenhouse (m).

$Q^{infilt}$  is the heat dissipation caused by infiltration through the greenhouse was obtained using :

$$Q^{infilt} = \rho_a C_a R \frac{(T_{in} - T_{out})}{3600} \quad (7)$$

$Q^{long}$  is the long wave radiation consumed by the greenhouse is determined by :

$$Q^{long} = h_o S (1 - \tau_c) (T_{in} - T_{sky}) \quad (8)$$

With, is the  $T_{sky}$  temperature that is determined using :

$$T_{sky} = 0.0552 (T_{out})^{1.5} \quad (9)$$

$Q^{vent}$  is the quantity of thermal energy loss from the cooling process is given by :

$$Q^{vent} = C_a R_v (T_{in} - T_{out}) \quad (10)$$

With,  $R_v$  is the ventilation rate ( $\text{m}^3.\text{s}^{-1}$ ).

The main input parameters of the cover and indoor air, used in this model, are listed in Table 1.

**Table 1:** Input parameters of the cover and indoor air

Symbol	Numerical value	Units	Description
$\rho_a$	1.137	$\text{Kg.m}^{-3}$	Density of internal air
$C_a$	1005	$\text{J.Kg}^{-1}.\text{K}^{-1}$	Specific heat of air
$\alpha_c$	0.1	-	Cover absorptivity of solar radiation
$\tau_c$	0.85	-	Cover transmittance

## 2.2 Experimental set-up

### 2.2.1 Description of the experimental greenhouse

In the present paper, the real greenhouse used in the experimental part is located at the Laboratory of Application for Energy Efficiency and Renewable Energies (LAPER). It is east-west oriented and has a chapel-shaped external structure maintained as shown in Figure 1. The geometrical characteristics of the greenhouse are the following: length = 150 cm; width = 100 cm; height = 115 cm.

**Fig. 1** Structure of the external view

### 2.2.2 Description of the measuring equipment

The database contains the following climatic parameters:  
 -The air temperature is measured by an LM35 sensor, with an accuracy of  $0.4^{\circ}\text{C}$  in the temperature range between  $-24^{\circ}\text{C}$  and  $48^{\circ}\text{C}$ .

-Relative humidity is measured by a sensor type SY-230. These sensors have a precision of the order 3% in the measurement margin between 0 and 95%.

-A pyranometer type LPYRA03 was used to measure the overall solar radiation level on a horizontal surface. The precision is around 5%.

-A three-cup anemometer is used to measure wind speed. The accuracy of this sensor is of the order of 1.5% or  $0.11 \text{ m.s}^{-1}$  in a measuring range between 0.45 and  $45 \text{ m.s}^{-1}$ .

## 3. Fuzzy logic controller

The fuzzy controller is considered a part of artificial intelligence. It has received growing interest in the scientific community, which explains why this controller allows solving the various control problems of multivariable and non-linear systems such as the greenhouse system. It has certain advantages that make it significantly preferable to other controllers such as its simplicity, flexibility and robustness.

### 3.1 Structure of the fuzzy logic control

A fuzzy logic control system is a successful real application implementation, it must be carried out in the program in three steps [23] illustrated in Figure 2.

Step 1. Fuzzification block: Fuzzification converts numerical data into fuzzy linguistic variables or membership functions (MF).

Step 2. Inference block: the MFs are integrated into the control rules to achieve the desired fuzzy result.

Step 3. A defuzzification process that produces a very precise control result for well-determined actuators.

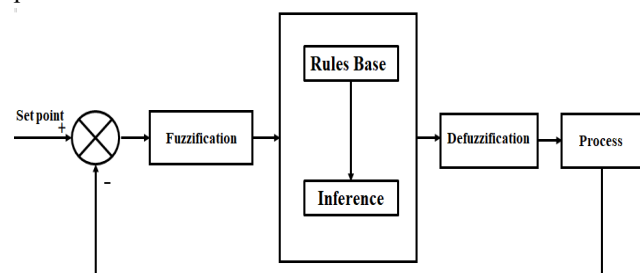
**Fig. 2** Fuzzy logic controller (FLC) architecture

### 3.2 Temperature fuzzy control

The temperature inside the greenhouse is an essential factor in plant growth. It is for this reason that the following part of this article presents the design and architecture of the fuzzy controller developed for this parameter. The considered system is described in Figure 3.

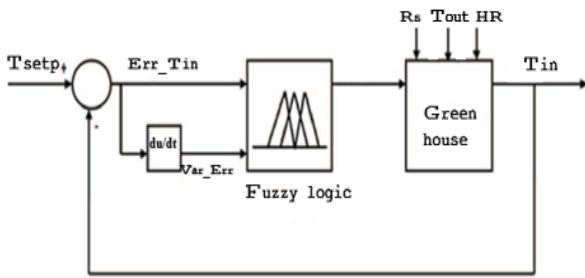

Fig. 3 Fuzzy control of the greenhouse air temperature

### 3.2.1 The inputs and output of the FLC

- Temperature Differences ( $E_{rr\_T_{in}}$ ): The inside temperature of the  $T_{in}$  greenhouse is compared with a predefined user set point  $T_{setp}$

$$E_{rr\_T_{in}} = T_{setp} - T_{in} \text{ (}^\circ\text{C)} \quad (11)$$

Where,  $E_{rr\_T_{in}} \in (N; \text{negative}; Z; \text{Zero}; P; \text{positive})$

- Rate of Change in Error ( $V_{ar\_E_{rr\_T_{in}}}$ ): Errors in the input variables related to variations in temperature are determined by finding the ratio for the difference between past and present temperature errors relative to the sampling time ( $\Delta t$ ), given by :

$$V_{ar\_E_{rr\_T_{in}}} = (E_{rr\_T_{in}}(k) - E_{rr\_T_{in}}(k - 1)) / \Delta t \quad (12)$$

$V_{ar\_E_{rr\_T_{in}}} \text{ (}^\circ\text{C/s)} \in (N; Z; P)$

- Ventilation rate (VR): The output actuator to control the internal climate of the greenhouse is the ventilation system.

Where,  $VR \in (NB; \text{Negative big}; NM; \text{Negative medium}; Z; PM; \text{Positive medium}; PB; \text{Positive big})$ .

The Figure 4 below shows the design of the Fuzzy Logic Designer application of our greenhouse system: with this application, the fuzzy controller can be expanded to add or remove input or output data, a fuzzy membership function, and IF Then rules and select fuzzy inference functions.

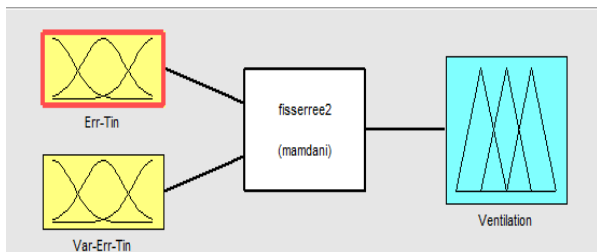

Fig. 4 Fuzzy logic designer application

### 3.2.2 The membership Functions

The fuzzy logic FLC is by default initialized by the membership functions of the internal air temperature error and by the variation of the temperature error to obtain the desired temperature by activating the actuator at a more adapted rate. Figure 5 and Table 2 show the membership functions of the temperature difference. Figure 6 and Table 3 show the membership functions of the variation in this error. Figure 7 and Table 4 presents the membership functions of the ventilation system.

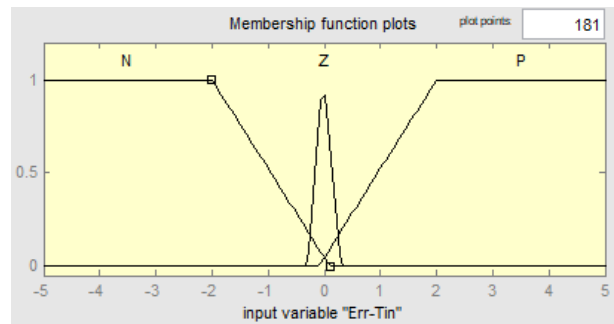

Fig. 5 MFs of temperature difference Err\_Tin

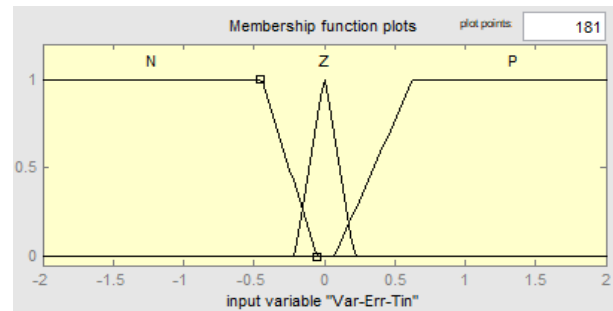

Fig. 6 MFs of change in Error Var\_Err\_Tin

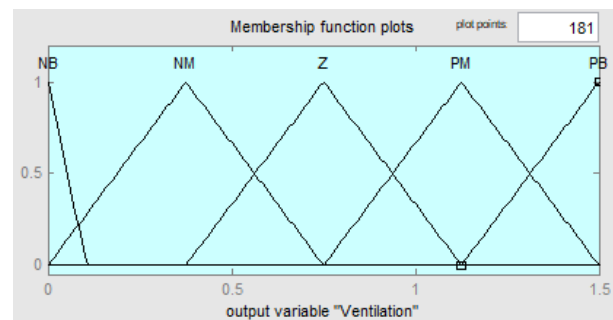

Fig. 7 MFs of Ventilation rate (VR)

**Table 2:** MFs of temperature difference  $E_{rr\_T_{in}}$

Input field	Range	Fuzzy set
Temperature difference ( $E_{rr\_T_{in}}$ )	[-8 -6 -2 0.1]	N
	[-0.3 -0.0265 0.3]	Z
	[-0.1 2 6 8]	P

**Table 3:** MFs of change in Error  $V_{ar\_E_{rr\_T_{in}}}$

Input field	Range	Fuzzy set
Rate of Change in Error ( $V_{ar\_E_{rr\_T_{in}}}$ )	[-10 -3 -0.45 -0.05]	N
	[-0.217 0 0.2169]	Z
	[0.07 0.63 3 10]	P

**Table 4:** MFs of Ventilation rate (VR)

Output field	Range	Fuzzy set
Ventilation rate (VR)	[-0.375 6.94e-18 0.1052]	NB
	[0 0.375 0.75]	NM
	[0.375 0.75 1.125]	Z
	[0.75 1.125 1.5]	PM
	[1.125 1.5 1.875]	PB

**3.2.3 Fuzzy Rule Base**

The rule base allows controlling the output variables as the most important part of the fuzzy inference system. In a relatively simplified way, a fuzzy rule is considered as a basic IF-THEN rule that contains a condition and a consequence.

The technique of fuzzy membership functions are first of all designed to transform the error  $E_{rr\_T_{in}}$  and the error change  $V_{ar\_E_{rr\_T_{in}}}$  into their fuzzy values. For the output, the command action is given by fuzzy rules in various error values/error changes. The default fuzzy rule for the command signal output is  $3 \times 3$ , which allows determining 9 rules for system control.

The rules of the fuzzy logic internal temperature control system of the greenhouse are shown in Table 5. This table includes the fuzzy logic necessary for this parameter of the greenhouse controlling system.

**Table 5:** Fuzzy rules base of the temperature control

Err-Tin / Var- Err-Tin	N	Z	P
N	NB	NM	Z
Z	NM	Z	PM
P	Z	PM	PB

**3.2.4 Defuzzification of the state variables**

The construction of the retained rules for the system control is as follows:

- IF (Err-Tin is N) and (Var-Err-Tin is N, Z, P) then (Ventilation is NB, NM, Z).
- IF (Err-Tin is Z) and (Var-Err-Tin is N, Z, P) then (Ventilation is NM, Z, PM).
- IF (Err-Tin is P) and (Var-Err-Tin is N, Z, P) then (Ventilation is Z, PM, PB).

The fuzzy inference technique applied in our application is the Mamdani method. There are different methods of defuzzification such as weighted average approach, maximum membership and center of gravity. The present analysis applies the centroid method.

**4. Simulation and results**

The dynamic model of the greenhouse system is developed to describe the internal temperature behavior using the MATLAB/Simulink interface. Simulink is a powerful environment for modeling and simulating linear and nonlinear dynamic systems. The developed model is shown in Figure 8. Figure 8 shows the fuzzy logic controller linked to our agricultural greenhouse to control the indoor temperature, where the input parameter is the temperature error and the change in error while the output parameter is the ventilation system.

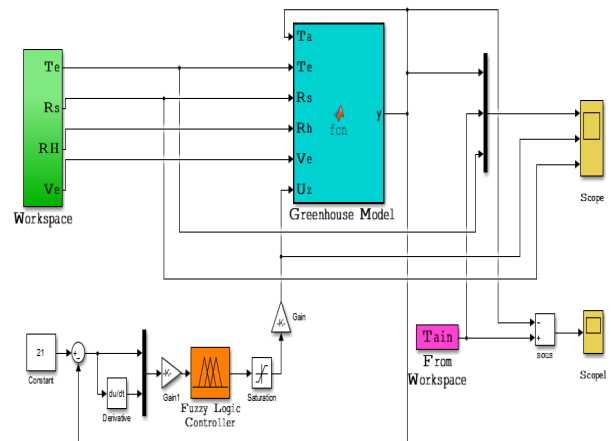

**Fig. 8** Simulink Model of the Greenhouse Air-Temperature

The modeling and control of our nonlinear system by the Simulink environment consists four main parts (Figure 8):

- The green color block subsystem presents the database of external climatic parameters (solar radiation, wind speed, ambient temperature and relative humidity).

- The cyan block represents the MATLAB functions under m.file, which are used to compute the different parts of the model to determine the evolution of indoor air temperature.
- The orange block presents the Fuzzy Logic Controller to command the ventilation system.
- The yellow blocks present the principal output results of the greenhouse model.

#### 4.1 Experimental database

For the present simulation, a database was recorded on 04/10/20 at the LAPER Laboratory. This database contains real meteorological measurements in our greenhouse system such as: solar radiation (Figure 9), relative humidity (Figure 10), outdoor and indoor air temperature (Figure 11).

In this period, the external solar radiation achieves a maximum of 12300 Lux during the day. During the day, solar radiation has an important effect in the greenhouse. Therefore, the different components of the greenhouse absorb radiant energy and convert it in thermal energy released in the air by heat transfer, thus increasing the indoor temperature which will exceed the outdoor temperature as shown in Figure 11.

The relative humidity presents a low variability between 64% and 82%. We can observe that if the outside temperature increases, the variation of the inside temperature automatically increases, conversely if it decreases the variation decreases. Therefore, the indoor temperature varies according to the outdoor temperature. They are highly correlated.

#### 4.2 Experimental validation

In this work we relied on the MATLAB/Simulink environment to predict the microclimate inside the greenhouse. In this analysis, it is used to predict and validate the proposed dynamic model of the internal air temperature, which is determined by applying Eq. (1).

The measured and calculated internal temperatures are presented in Figure 12. Figure 13 shows the error between them. In Figure 14 we can find the results of the simulation of the fuzzy logic controlled temperature greenhouse. The last figure presents the ventilation rate. The set point is chosen according to the preferred plant growth. In our present work we have chosen the set point temperature 21 °C during the whole day. In practical terms, with the fuzzy controller when the internal temperature starts to be higher than the reference temperature, the ventilation system starts to operate to lower the temperature until the desired set point is reached.

Figure 12 shows the efficiency of the proposed thermal model and convincingly describes the evolution of the indoor air temperature in the greenhouse.

From Figure 13, it appears that the error between the internal temperature and the measured temperature is about 1.5%. This value shows that the proposed model is demonstrated to fit accurately to measured data and can be considered for simulation as well as analysis and synthesis of climate controllers.

Figure 14 illustrates that the established fuzzy logic controller presented a perfect way to achieve the desired microclimate inside the greenhouse and it always points to the desired trajectory, which proves its efficiency and robustness, but the control device has a high switching level due to measurement errors that affect the response of the controller.

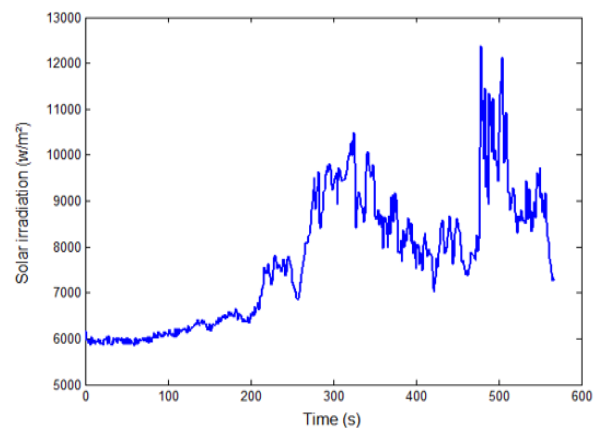

Fig. 9 Global solar radiation intensity

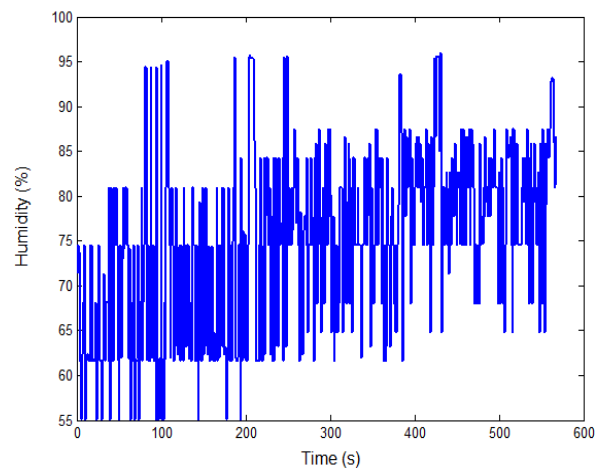

Fig. 10 Relative Humidity



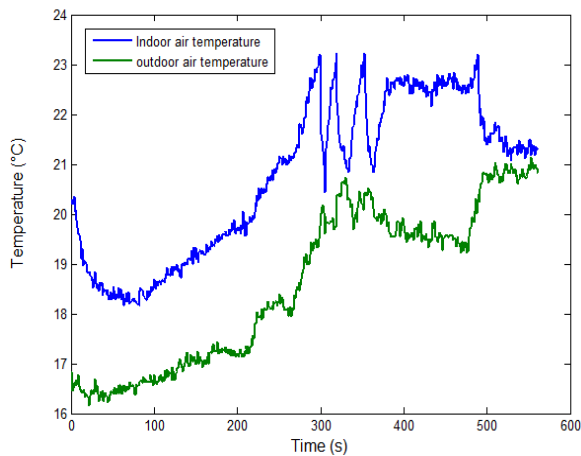

Fig.11 Outdoor and Indoor air temperature

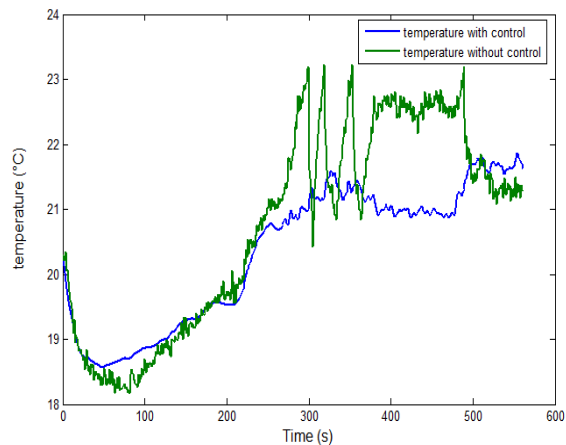
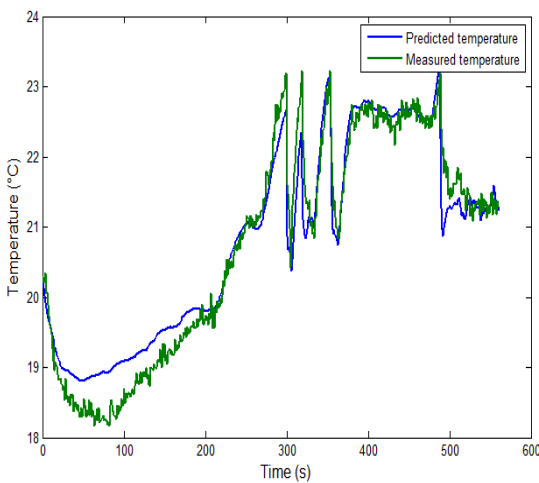

Fig.14 The evolution of indoor air temperatures with and without controller FLC



Predicted and measured air temperatures indoor the greenhouse

Fig. 12

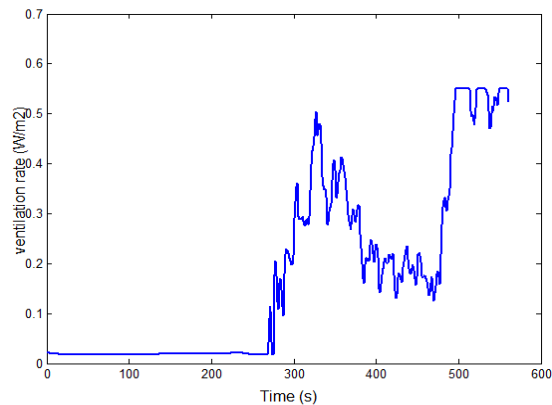

Fig.15 The ventilation rate

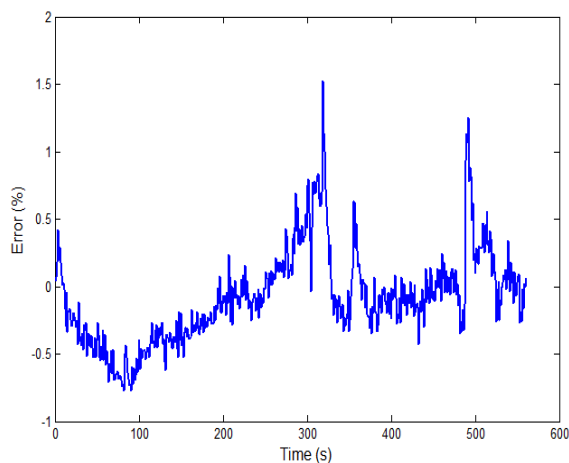

Fig.13 Error predicted and measured air temperatures indoor the greenhouse

### 5. Conclusion

In the present paper, the work is developed from the experiments carried out at Laboratory of Application for Energy Efficiency and Renewable Energies (LAPER) in Tunisia.

A dynamic model was proposed and implemented using the MATLAB/Simulink environment to predict the indoor air temperature in the greenhouse. Simulation results showed that the dynamic model of the proposed system has been experimentally validated.

The low percentage error between predicted and measured indoor temperature values proves the effectiveness of the model in predicting the microclimate inside the greenhouse. Thus, the thermal model studied can convincingly describe the evolution of the indoor temperature when simulating the result of a control law. Consequently, the desired objective is achieved which clear the path on using the fuzzy logic controller and

discuss its results. Although its simplicity, the controller solved the complex problem without any interaction with physical variables and was considered an excellent tool to achieve the desired microclimate inside the greenhouse, resulting in a reduction of the indoor air temperature to 21°C. Simulations proved the performance of the regulator developed to meet the requirements of the plants in real time, in terms of temperature.

## References

- [1] L. M. Mortensen, "Growth responses of some greenhouse plants to environment: III. Design and function of a growth chamber prototype", *Scientia Horticulturae*, Vol. 16, No. 1, pp. 57-63, 1982.
- [2] Imen Haj Hamad, Hajer Bouzaouache, "Gestion et Instrumentation d'une Serre Agricole: Réalisation Expérimentale", 5ème Conférence Internationale des Energies Renouvelables (CIER 2017). Sousse, Tunisie, 2017.
- [3] H Bouzaouache, NB Braiek, M Benreheb, "Reduced optimal control of nonlinear singularly perturbed systems," *Systems Analysis Modelling Simulation* 43 (1), 75-87, 2003.
- [4] Hajer Bouzaouache, "Tensor Product-Based Model Transformation and Optimal Controller Design for High Order Nonlinear Singularly Perturbed Systems", Vol 22, N°1, pp486-499, *Asian Journal of Control*, 2020.
- [5] Marwa Baccouche, Hajer Bouzaouache, "Successive separation procedure of reduction for nonlinear large scale systems", *Indian Journal of Science and Technology*, 2017.
- [6] O. Jolliet, L. Danloy, J.-B. Gay a, G.L. Munday, and A. Reist, "HORTICERN: an improved static model for predicting the energy consumption of a greenhouse," *Agricultural and Forest Meteorology* 55, pp.265-294, 1991.
- [7] S. Bouadila, M. Lazaar, S. Skouri, S. Kooli, and A. Farhat, "Assessment of the greenhouse climate with a new packed-bed solar air heater at night, in Tunisia," *Renewable and Sustainable Energy Reviews* 35, pp. 31-41, 2014.
- [8] M.C. Singh, J.P. Singh, K.G. Singh, "Development of a microclimate model for prediction of temperatures inside a naturally ventilated greenhouse under cucumber crop in soilless media, *Comput. Electron. Agric.* 154 (2018) 227-238.
- [9] H.G. Mobtaker, Y. Ajabshirchi, S.F. Ranjbar, M. Matloobi, "Simulation of thermal performance of solar greenhouse in north-west of Iran: an experimental validation, *Renew. Energy* (2018).
- [10] G. D. Pasgianos, K. G. Arvanitis, P. Polycarpou, N. Sigrimis, "A nonlinear feedback technique for greenhouse environmental control", *Computer and Electronics Agriculture*, Vol. 40, No. 1-3, pp. 153-177, 2003.
- [11] C. J. Taylor, P. C. Young, A. Chotai, A. R. Mcleod, A. R. Glascock, "Modelling and proportional-integral-plus control design for free air carbon dioxide enrichment systems", *Journal of Agricultural Engineering Research*, Vol. 75, No. 4, pp. 365-374, 2000.
- [12] E. J. V. Henten, J. Bontsema, "Time-scale decomposition of an optimal control problem in greenhouse climate management", *ControlEngineering Practice*, Vol. 17, No. 1, pp. 88-96, 2009.
- [13] H Bouzaouache "Calculus of variations and nonlinear optimization based algorithm for optimal control of hybrid systems with controlled switching. *Complexity* 2017.
- [14] Amira Labidi, Amine Chouchaine, and Abdelkader Mami, "Greenhouse Humidity Control based on Fuzzy Logic", *IJCSNS International Journal of Computer Science and Network Security*, VOL.20 No.10, October 2020.
- [15] D.M. Atia, H.T. El-madany, "Analysis and design of greenhouse temperature control using adaptive neuro-fuzzy inference system, *J. Electr. Syst. Inf. Technol.* (2016).
- [16] A. Pawlowski, M. Beschi, J.L. Guzmán, A. Visioli, M. Berenguel, S. Dormido, "Application of SSOD-PI and PI-SSOD event-based controllers to greenhouse climatic control, *ISA Trans.* 65 (2016) 525-536.
- [17] Q. Zou, J. Ji, S. Zhang, M. Shi, Y. Luo, "Model Predictive Control Based on Particle Swarm Optimization of Greenhouse Climate for Saving Energy Consumption", *World Automation Congress*, Kobe, Japan, September 19-23, 2010.
- [18] M. Nachidi, F. Rodriguez, F. Tadeo, J. L. Guzman, "Takagi-sugeno control of nocturnal temperature in greenhouses using air heating, *ISA Transactions*, Vol. 50, No. 2, pp. 315-320, 2011.
- [19] A.Chouchaine, E.Feki, and A.Mami, "Stabilization Using a Discrete Fuzzy PDC Control with PID Controllers and Pole Placement: Application to an Experimental Greenhouse," *Journal of Control Science and Engineering*, 2011.
- [20] S. Zeng, H. Hu, L. Xu, and G. Li, "Nonlinear Adaptive PID Control for Greenhouse Environment Based on RBF Network," *Sensors*, 2012.
- [21] R. Ben Ali, S. Bouadila, A. Mami, "Development of a Fuzzy Logic Controller applied to an agricultural greenhouse experimentally validated, *Appl. Therm. Eng.* 141 (2018) 798-810.
- [22] Fahmy F. Harghally H. M., Ahmed N. M. and Nafeh A. A., 2012, "Modelling and Simulation of Evaporative Cooling System in Controlled Environment Greenhouse", *Smart grid and renewable Energy*, 3, pp. 67-71.
- [23] Y. Bai and D. Wang, "Fundamentals of fuzzy logic control fuzzy sets, fuzzy rules and defuzzifications," in *Advances in Industrial Control*, pp. 17-36, Springer, London, UK, 2006.